



# Contents

<b>1. Product Introduction</b> .....	<b>1</b>
1.1. What's in the Box .....	1
1.2. Identifying Parts and Controls .....	2
1.3. Parameter Settings .....	2
1.4. How to open and setup the monitor .....	2
<b>2. Setup and Connection</b> .....	<b>5</b>
2.1. Driver Download and Installation .....	5
2.2. For Windows .....	5
2.3. For macOS .....	7
2.4. Connect the Laptop/PC with a Type-C to Type-C Cable .....	8
2.5. Connect the Laptop/PC with a USB A-C and HDMI Cable .....	8
2.6. Connect the Laptop/PC with HDMI Cable .....	9
2.7. Windows Display Setup .....	9
2.8. macOS Display Setup .....	10
<b>3. Specifications</b> .....	<b>12</b>
3.1. Technical specifications .....	13
<b>4. Trouble Shooting</b> .....	<b>14</b>
4.1. How to connect correctly? .....	14
4.2. Only part of monitor works. ....	15
4.3. All displays are non-operational? .....	16
4.4. Why is there a difference in color between the middle/right screens and the laptop/left screen? (masOS only) .....	16
.....	16

---

# 1. Product Introduction

## 1.1. What's in the Box

Please contact us if anything is missing or damaged.



TriCreate Pro Monitor



USB A-C (black) , 1 meter USB A to Type-C cable for video signal transmission



USB C-C (white) , 2 meters USB Type-C to Type-C cable for power delivery



USB C-C (black) , 1 meter Full Feature USB Type-C to Type-C cable for video signal transmission



HDMI-mini HDMI (black) , 1 meter HDMI cable for HDMI signal transmission



Power Adapter (white) , connect the USB C-C Cable to power up the monitor



## 1.2. Identifying Parts and Controls

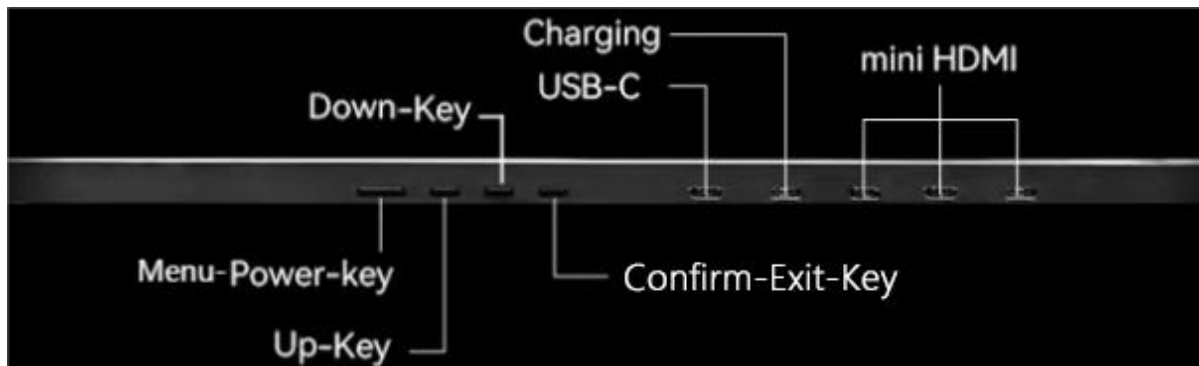

**USB-C:** Audio and video signal transmission.

**Charging:** Power supply to this Type-C charging port is mandatory.

**3 x Mini HDMI:** Audio and video signal transmission, directly connected to each monitor.

**Menu-Power-Key:** Short press to activate the OSD menu of each monitor, long press (more than 1 second) to turn off/on the monitor.

**Up-Key/+ Key:** To select the setting or turn up the value, turn up the volume or brightness.

**Down-Key/- Key:** To select the setting or turn down the value, turn down the volume or brightness.

**Confirm-Exit-Key:** Short press to enter the next step or confirm the value in the OSD menu setting, long press to exit the current menu.

## 1.3. Parameter Settings

There are different parameter settings for the triple monitors.

Configure the display parameters according to the following instructions.

1. Short press the **Menu-Power-Key** to activate the OSD menu of one monitor, or short press again to switch to another monitor.
2. Press the **Up/Down Key** to switch menus.
3. Press the **Confirm-Exit-Key** to confirm.
4. Press the **Up/Down Key** to adjust the value.

## 1.4. How to open and setup the monitor

- 1) Put the TriCreate Pro on your desktop with the right direction as the following figure.



2) Unfold the stand as the following and fix the stand.



3) Rotate the triple folded monitors about 135° to make it straight.



4) Unfold the triple monitors, and adjust the best viewing angle for you.



- 5) Please follow the steps from above 4 to 1 to fold the TriCreate Pro monitor while you are going to take it.

---

## 2. Setup and Connection

### 2.1. Driver Download and Installation

Before connecting the monitor to your computer for the first time, you must complete the driver installation to enable the Type C-C or USB A-C display function.

Method 1 (Recommended): Use your device to scan the QR code below to go directly to the download page.

Method 2: Manually download from the official website below:

<https://www.synaptics.com/products/displaylink-graphics/downloads>

Please download and run the installer, then follow the on-screen instructions to complete the installation.

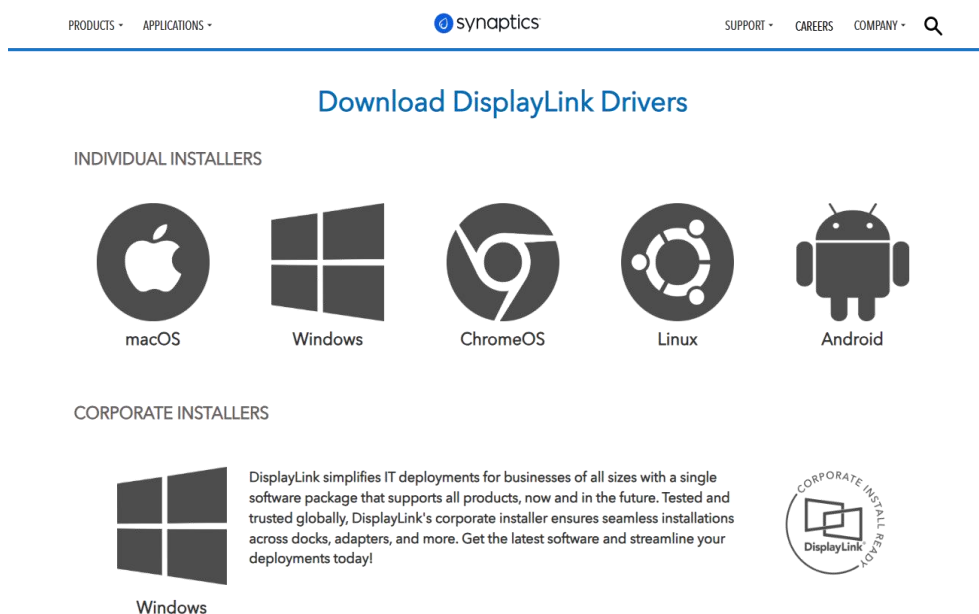

It supports Windows, macOS and Linux.

### 2.2. For Windows

1. Download the corresponding driver version for your operating system from the official website.

## Windows Driver Downloads

Here you can download drivers for DisplayLink® USB graphics chipsets incorporated in your dock, adapter or monitor. We recommend to update to the latest driver to address any potential security issue, fix bugs, improve performance and add new features.

Notes:

1. Your Original Equipment Manufacturer (OEM) may also provide software for your specific monitor, dock or adapter that differs from the DisplayLink releases. Please check their website for details.
2. Windows 10 S products using DisplayLink technology will get their device drivers either from OEM pre-installation or from Windows Update.

### Latest Official Drivers

DisplayLink USB Graphics  
Software for Windows

Windows 11, Windows 10  
Release: 12.1 | Sep 12, 2025

[Download](#)  
[Release Notes](#)

2. Run the installer and follow the prompts to complete the installation. The triple-screen display will then be activated.

DisplayLink Graphics

### DisplayLink® Graphics

- 系统检查 系统兼容性检查  
DisplayLink 系统兼容性检查已成功通过，可继续安装
- 安装
- 完成

[自定义您的显示屏](#)

从 Microsoft Store 获取 DisplayLink Manager – 屏幕管理工具的更新使配置显示器比以往更加容易。

[完成\(F\)](#) [取消](#)

DisplayLink Graphics

### DisplayLink® Graphics

- 系统检查 安装完成
- 安装
- 完成

[自定义您的显示屏](#)

从 Microsoft Store 获取 DisplayLink Manager – 屏幕管理工具的更新使配置显示器比以往更加容易。

[完成\(F\)](#)

---

## 2.3. For macOS

1. Download the corresponding driver version for your operating system from the official website.

### DisplayLink macOS Software

DisplayLink Manager is a new way to enable your DisplayLink dock, adapter or monitor on macOS platforms. It's an application that combines our latest driver with features that streamline the setup of multiple displays up to 4K.



2. Run the installer and follow the prompts to complete the installation.

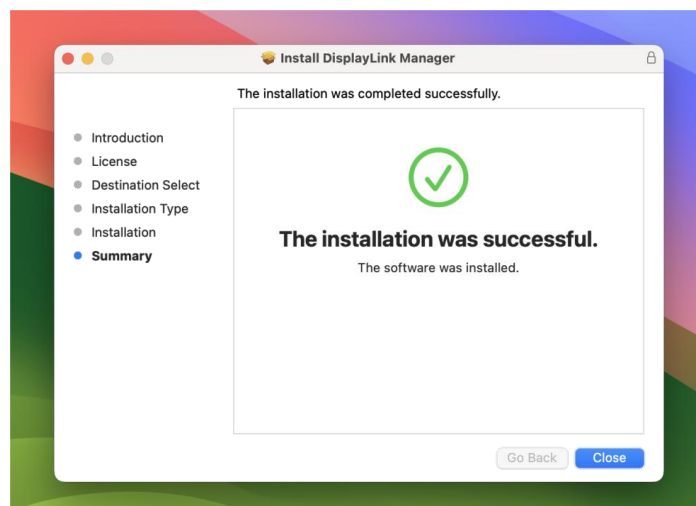
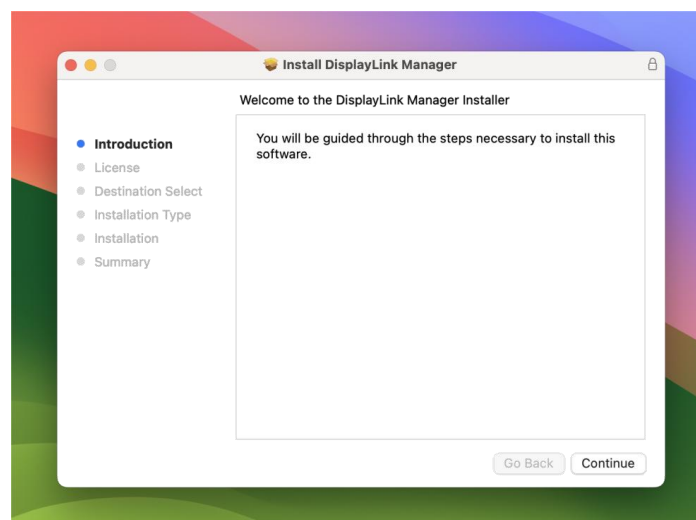

3. Go to Settings > Privacy & Security > Screen & System Audio Recording and enable permission for DisplayLink Manager to activate triple-screen display.

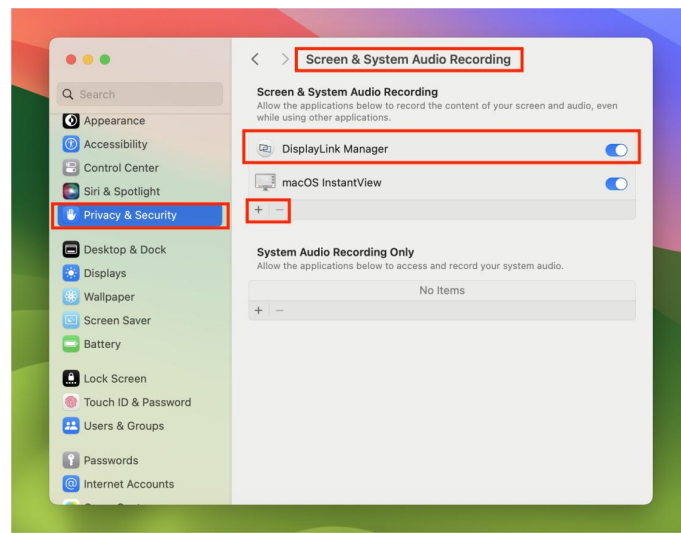

## 2.4. Connect the Laptop/PC with a Type-C to Type-C Cable



1. Plug in the power adapter with Type-C to Type-C charging cable to the monitor.
2. Connect the monitor to the Type C port of PC/Laptop with Type C to Type C cable.

### Note:

- The external power supply is mandatory because the output power from the Type C port of laptop/PC is not enough.
- The Type C port of PC/Laptop must have the display and USB function at the same time.

## 2.5. Connect the Laptop/PC with a USB A-C and HDMI Cable



1. Plug in the power adapter with Type-C to Type-C charging cable to the monitor.
2. Connect the monitor to USB port of PC/Laptop with USB to Type C cable.
3. Connect the monitor to HDMI port of PC/Laptop with HDMI to HDMI mini cable.

## 2.6. Connect the Laptop/PC with HDMI Cable



1. Plug in the power adapter with Type-C to Type-C charging cable to the monitor.
2. Connect the monitor to HDMI port of PC/Laptop with HDMI to HDMI mini cable which directly connected to different monitor.

## 2.7. Windows Display Setup

1. After the DisplayLink Manager driver was successfully installed, connected the Windows PC. And then enter the system **Settings**.

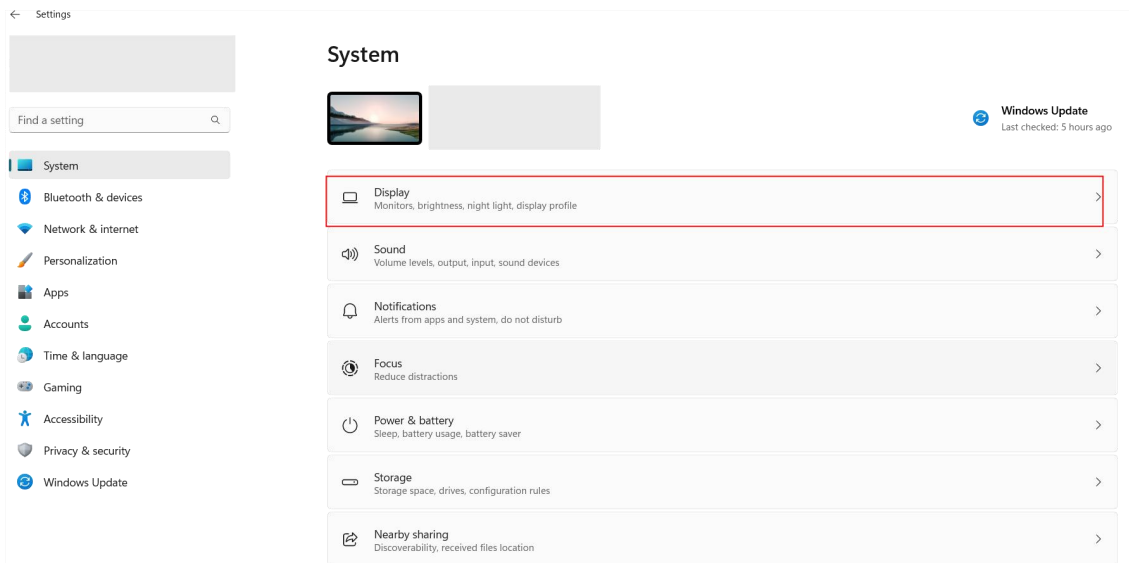

2. Enter **Display** settings.

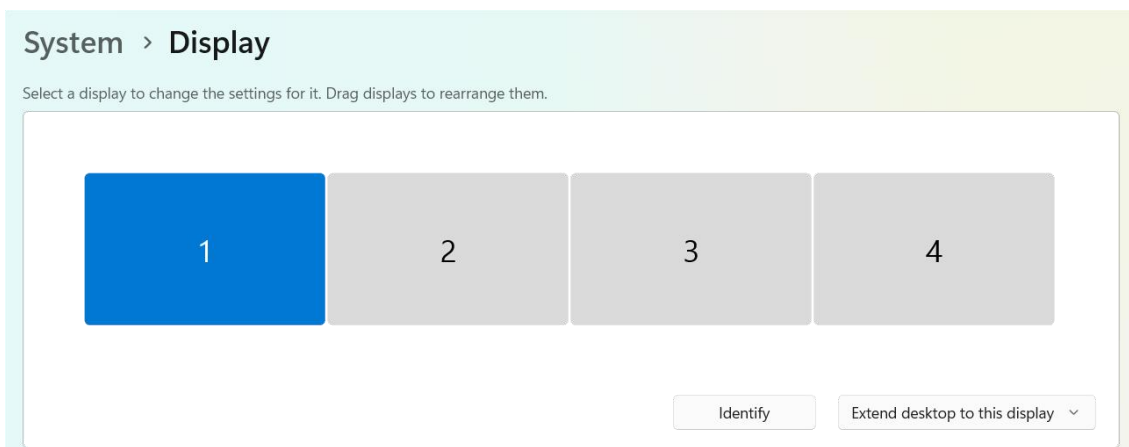

3. Scroll down to select Duplicate these displays or Extend these displays.

1) For extended displays, normally arrange like the following one.

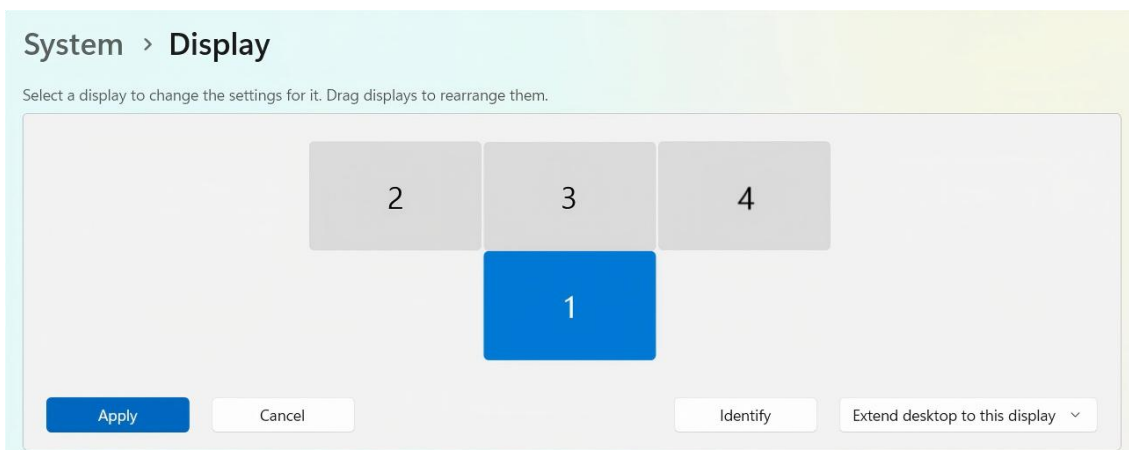

Note: if you are not sure the actual number for each monitor, click **Identify** and the number will be showed on each monitor.

2) Windows only supports two displays duplicated currently.

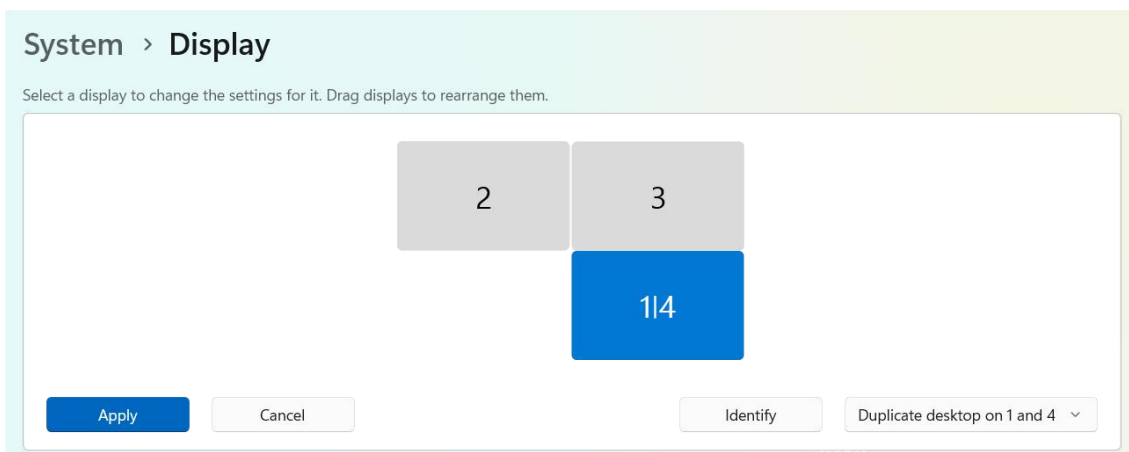

4. You can drag the displays to rearrange them to match the actual position of the monitors and click **Apply** to confirm your rearrangement.

## 2.8. macOS Display Setup

1. After the DisplayLink Manager driver was successfully installed, connected the Mac PC. Enter the **System Preferences** and click **Displays**. Drag the display to rearrange the position to match the actual position of the monitors.

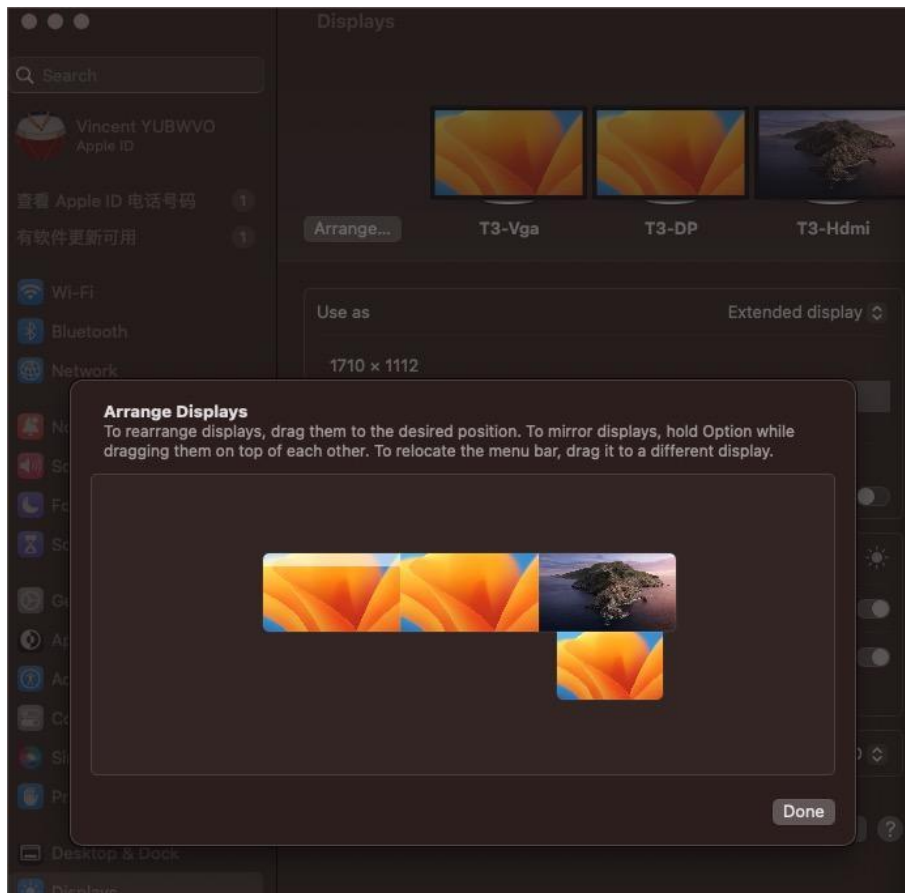

2. Click **Display Settings**, and then scroll Down to the **Use as** area and select **Stop Mirroring** to use as the extended display.

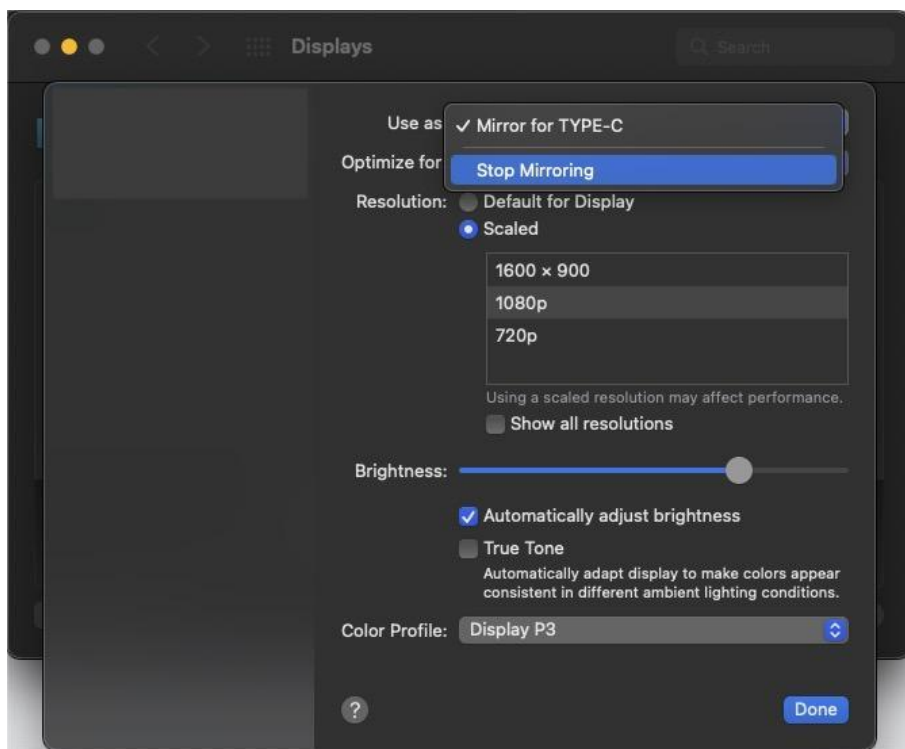

---

### 3. Specifications

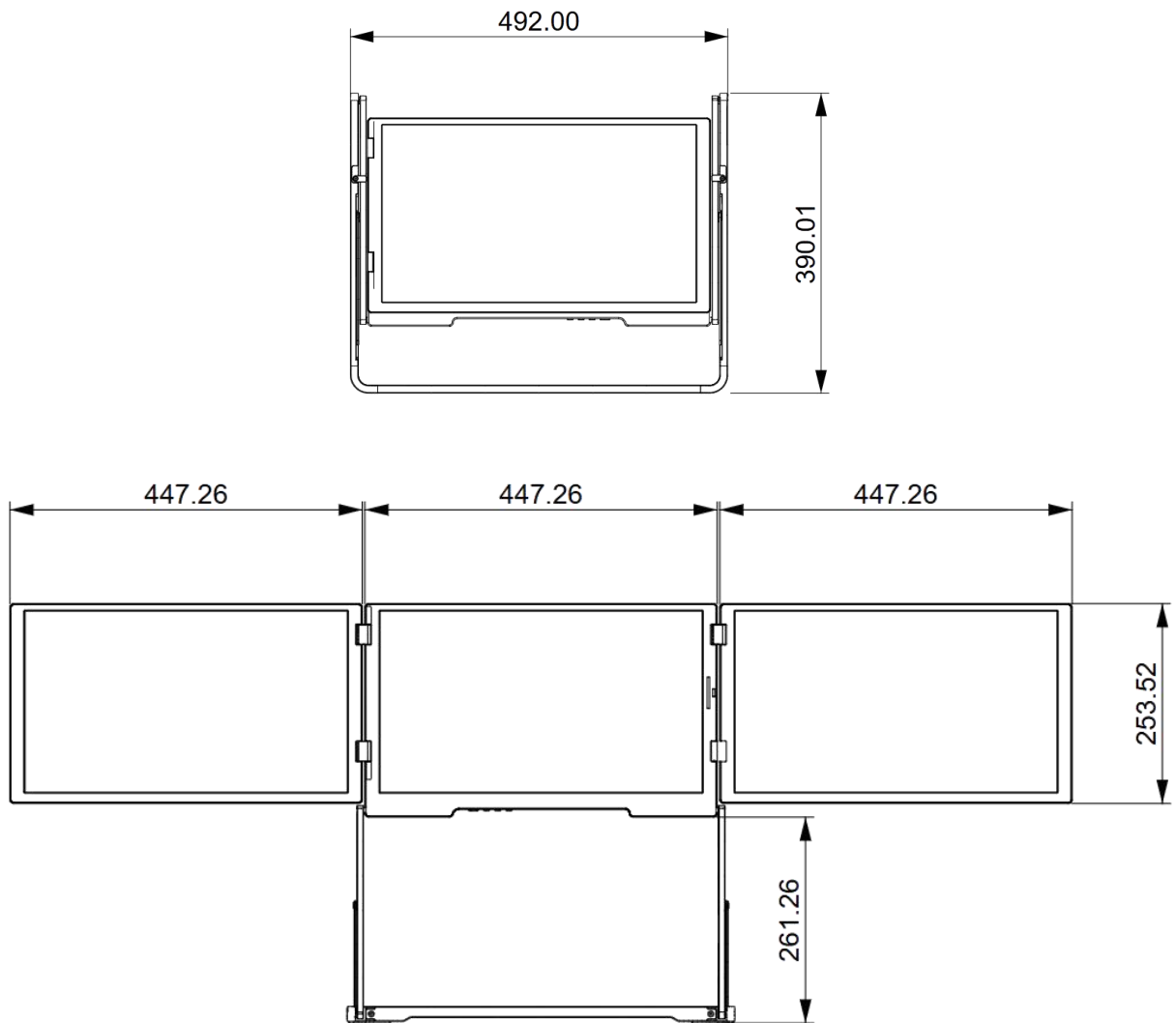

### 3.1. Technical specifications

Description	Parameters	
Model	TriCreate Pro (FHD)	TriCreate Pro (QHD)
Panel Size	3 x 18.5"	
Aspect Ratio	16 : 9	
Panel Type	IPS	
Screen Cover Type	PC front bezel	
Color gamut	100% sRGB	
Resolution	1920 x 1080p	2560 x 1440p
Brightness (Typ.)	300(±30) Nits	380(±30) Nits
Refresh Rate	60 Hz	
View Angles	85/85/85/85 (Typ.)(CR≥10)	
Response Time	10 ms	
Connectivity	1 x USB Type-C for triple monitors 1 x USB A-C + 1 x mini HDMI for triple monitors 3 x mini HDMI for each monitor directly	
Fold Angle	0~ 360°	
Speaker	2 x 6Ω 2W	
Keys	4 Keys: Menu/Power, Up/+, Down/-, Confirm/Exit	
Compatible systems	Windows, macOS, Linux	
Net Weight	4.4 kg	
Dimension	Unfolding: 1341 x 390 x 400-530 mm Folded: 492 x 390 x 30 mm	
Shell Material	Aluminum alloy	

---

## 4. Trouble Shooting

**NOTE1:** TriCreate Pro only supports Windows, macOS and Linux system, otherwise only single monitor for HDMI directly connected.

**NOTE2:** All cables included with this product support video signal transmission. (Excluding the charging cable)

### 4.1. How to connect correctly?

Please make sure you're using the cables that we provide. The right connections are as following pictures:

1. **If the USB-C port on your computer supports video signal transmission**, please connect using a full-function USB-C to USB-C cable. The connection method is shown in the figure below.



2. **If the USB-C port on your computer does not support video signal transmission**, but the USB-A port does, please connect using one USB-A to USB-C cable that supports video signal transmission plus one HDMI cable. The connection method is shown in the figure below.



3. **If your computer has a sufficient number of HDMI ports**, you may establish the connection using three HDMI cables, as illustrated in the diagram below.



## 4.2. Only part of monitor works.

### 1. Only left monitor works.

1) Please check the driver has already installed correctly. MacBook user please check the Screen & System Audio Recording has already turned on.

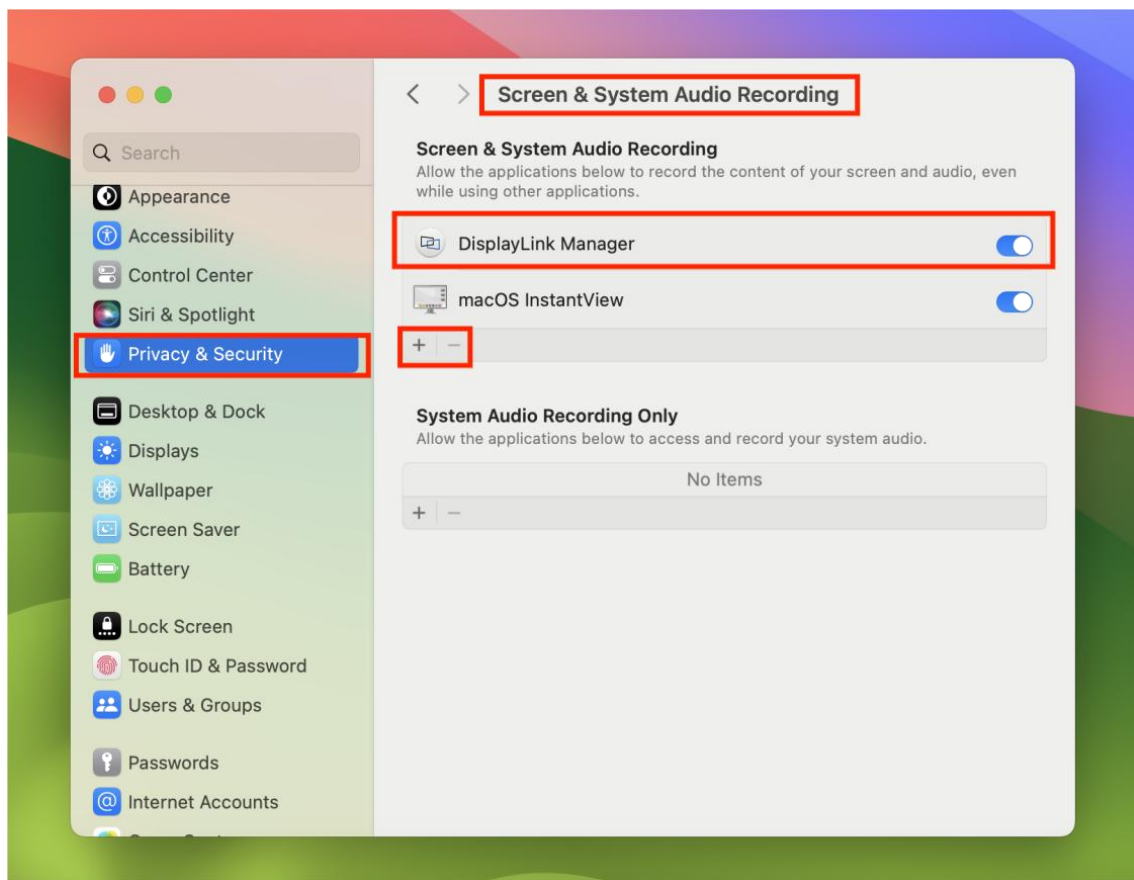

2) One HDMI cable only support one monitor. If your laptop has a full-function Type-C port, please change to Type-C to Type-C cable; If your laptop does not have a full-function Type-C port, please use USB A-C + HDMI, HDMI plug in the left HDMI port. See the connection diagram below.



## 2. Only middle and right monitor work.

The main reason is the Type-C port of your laptop does not support Type-C display function, not full-function Type-C, it needs to plug in HDMI to the left port to make it triple display. See the connection diagram below.



## 3. Only middle monitor works.

The main reason is one HDMI plug in the middle HDMI port only support the middle monitor works, it needs to plug in three HDMI to make it triple display, or you can use a full-function Type-C cable instead.

## 4. Only right monitor works.

The main reason is one HDMI plug in the right HDMI port only support the right monitor works, it needs to plug in three HDMI to make it triple display, or you can use a full-function Type-C cable instead.

## 4.3. All displays are non-operational?

Please ensure the monitor is connected to a power adapter. If the power connection is normal, try long-pressing the power button at the bottom of the screen to turn it on.

## 4.4. Why is there a difference in color between the middle/right screens and the laptop/left screen? (masOS only)

1. Please ensure True Tone is turned off in your Display settings.
2. Each display has its own configurable settings. Please verify that the display parameters (like color profile and brightness) are consistent across all screens.